

CPRI Bhopal

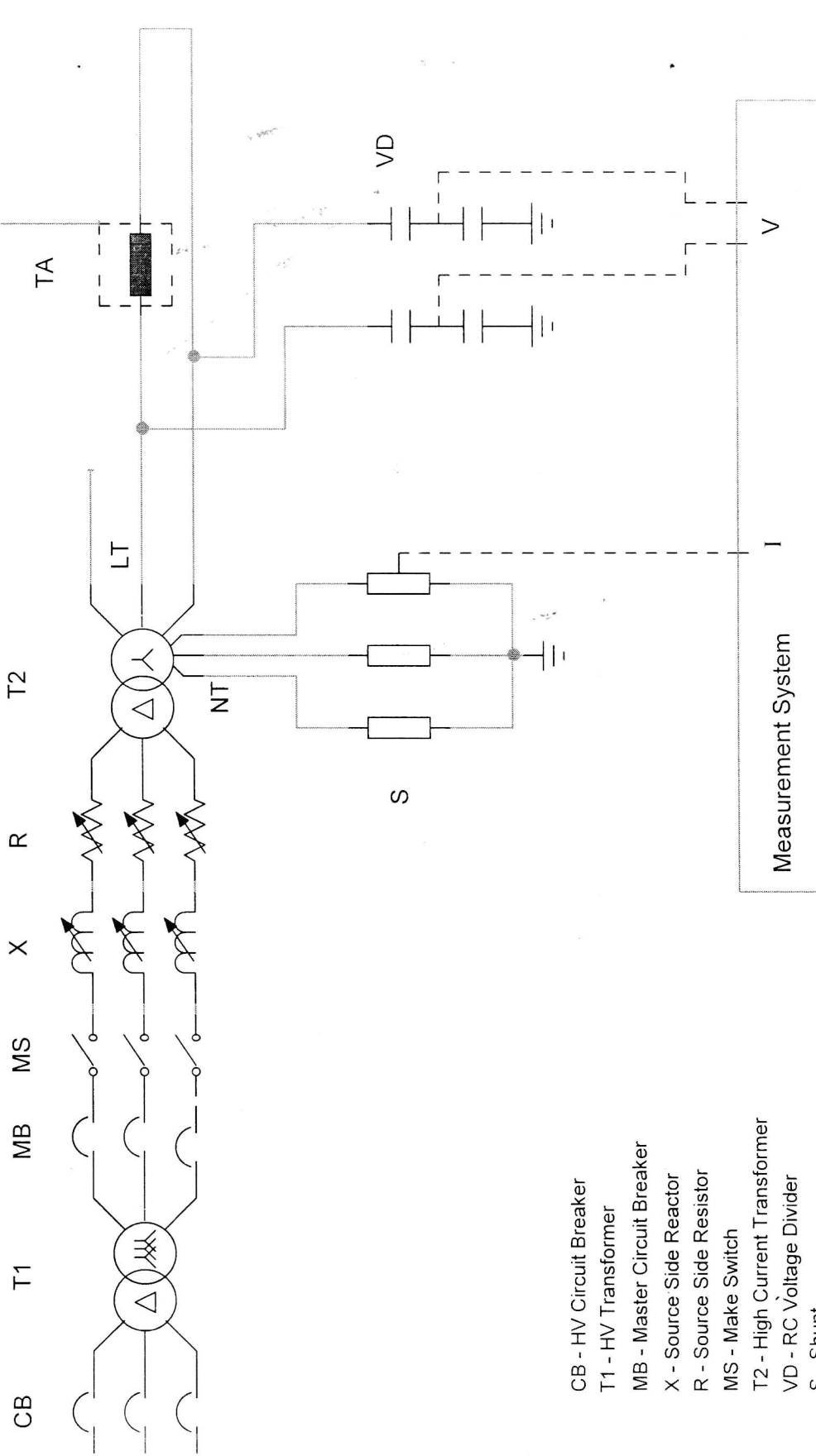

- CB - HV Circuit Breaker
- T1 - HV Transformer
- MB - Master Circuit Breaker
- X - Source Side Reactor
- R - Source Side Resistor
- MS - Make Switch
- T2 - High Current Transformer
- VD - RC Voltage Divider
- S - Shunt
- TA - Test Apparatus
- r - Current Limiting Resistor
- FWF - Fine Wire Fuse
- LT - Line terminals of the secondary windings of T2
- NT - Neutral terminals of the secondary windings of T2

TEST ENGINEER

OLTS/TCD-STC-02